

Use & Care MANUAL

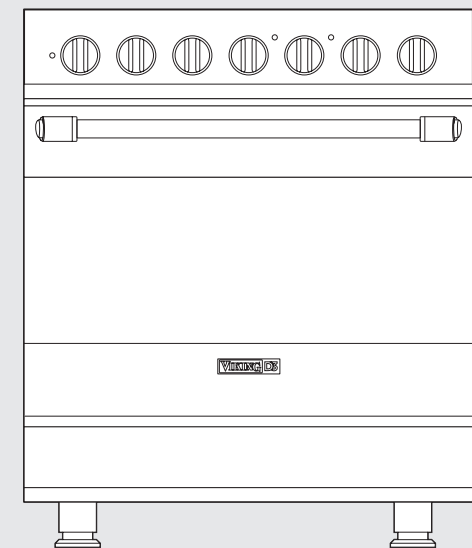

Viking Range Corporation
111 Front Street
Greenwood, Mississippi 38930 USA
(662) 455-1200

For product information, call 1-888-845-4641
or visit the Viking Web site at vikingrange.com



VIKING | D3
Freestanding 30"
Electric Self-Clean Range

Congratulations

Congratulations and welcome to the elite world of Viking ownership. We hope you will enjoy and appreciate the care and attention we have put into every detail of your new, state-of-the-art self-cleaning range.

Your Viking range is designed to offer years of reliable service. This Use and Care Manual will provide you with the information you need to become familiar with your product's care and operation.

Your complete satisfaction is our ultimate goal. If you have any questions or comments about this product, please contact the dealer from whom you purchased it, or contact our Consumer Support Center at 1-888-845-4641.

We appreciate your choice of a Viking range and hope that you will again select our products for your other major appliance needs.

For more information about the complete and growing selection of Viking products, contact your dealer or visit us online at www.vikingrange.com.

Table of Contents

Getting Started

Warnings and Important Safety Instructions	4
Before Using Range	13

Product Controls

Range Features	14
Oven Functions and Settings	15

Operation

Surface Operation	16
Surface Heat Settings	17
Cooking Vessels	17
Oven Features	18
Rack Positions	18
Using the Oven	19
Preheat	19
Conventional and Convection Cooking	20
Baking	22
BAKE (Two-Element Bake)	22
CONV BAKE (Convection Bake)	22
TRU CONV (TruConvec™)	23
Roasting	27
CONV ROAST (Convection Roast)	27
Broiling	31
CONV BROIL (Convection Broil)	31
HI BROIL	31
MED BROIL	31
LOW BROIL	32
Convection Dehydrate	35
Convection Defrost	35

Product Care

Cleaning and Maintenance	37
Self-Clean Cycle	42
Replacing Oven Lights	44
Door Removal	45
Door Replacement and Adjustment	46
Troubleshooting	47
Service Information	48
Warranty	49

Warnings

Warning and Important Safety Instructions appearing in this manual are not meant to cover all possible conditions and situations that may occur. Common sense, caution, and care must be exercised when installing, maintaining, or operating this appliance.

ALWAYS contact the manufacturer about problems or conditions you do not understand.

Recognize Safety Symbols, Words, Labels

DANGER

Hazards or unsafe practices which **WILL** result in severe personal injury or death

WARNING

Hazards or unsafe practices which **COULD** result in death or severe personal injury

CAUTION

Hazards or unsafe practices which **COULD** result in minor personal injury or property damage.

All safety messages will identify the hazard, tell you how to reduce the chance of injury, and tell you what can happen if the instructions are not followed.

Read and follow all instructions before using this appliance to prevent the potential risk of fire, electric shock, personal injury or damage to the appliance as a result of improper usage of the appliance. Use appliance only for its intended purpose as described in this manual.

To ensure proper and safe operation: Appliance must be properly installed and grounded by a qualified technician. **DO NOT** attempt to adjust, repair, service, or replace any part of your appliance unless it is specifically recommended in this manual. All other servicing should be referred to a qualified servicer.

WARNING



Tipping hazard.

To reduce the risk of the appliance tipping, it must be secured by a properly installed anti-tip bracket(s).

To make sure the bracket has been installed properly, look behind the range with a flashlight to verify proper installation engaged in the rear top left corner of the range.

- THIS RANGE CAN TIP.
- INJURIES TO PERSONS CAN RESULT.
- INSTALL ANTI-TIP DEVICE PACKED WITH RANGE.
- SEE INSTALLATION INSTRUCTIONS.

WARNING



To avoid risk of property damage, personal injury or death; follow information in this manual exactly to prevent a fire or explosion, **DO NOT** store or use gasoline or other flammable vapors and liquids in the vicinity of this or any appliance.

Warnings

To Prevent Fire or Smoke Damage

- Be sure all packing materials are removed from the appliance before operating it.
- Keep area around appliance clear and free from combustible materials, gasoline, and other flammable vapors and materials.
- If appliance is installed near a window, proper precautions should be taken to prevent curtains from blowing over burners.
- **NEVER** leave any items on the rangetop. The hot air from the vent may ignite flammable items and may increase pressure in closed containers which may cause them to burst.
- Many aerosol-type spray cans are **EXPLOSIVE** when exposed to heat and may be highly flammable. Avoid their use or storage near an appliance.
- Many plastics are vulnerable to heat. Keep plastics away from parts of the appliance that may become warm or hot. **DO NOT** leave plastic items on the rangetop as they may melt or soften if left too close to the vent or a surface element.
- Combustible items (paper, plastic, etc.) may ignite and metallic items may become hot and cause burns. **DO NOT** pour spirits over hot foods. **DO NOT** leave oven unsupervised when drying herbs, breads, mushrooms, etc; fire hazard.

In Case of Fire

Turn off appliance and ventilating hood to avoid spreading the flame. Extinguish flame then turn on hood to remove smoke and odor.

- **Cooking Surface:** Smother fire or flame in a pan with a lid or cookie sheet.
- **NEVER** pick up or move a flaming pan.
- **Oven:** Smother fire or flame by closing the oven door.
DO NOT use water on grease fires. Use baking soda, a dry chemical or foam-type extinguisher to smother fire or flame.

Child Safety

- To eliminate the hazard of reaching over hot surface elements, cabinet storage should not be provided directly above a unit. If storage is provided, it should be limited to items which are used infrequently and which are safely stored in an area subjected to heat from an appliance. Temperatures may be unsafe for some items, such as volatile liquids, cleaners or aerosol sprays.
- **NEVER** leave children alone or unsupervised near the appliance when it is in use or is still hot.
- **NEVER** allow children to sit or stand on any part of the appliance as they could be injured or burned.
- **DO NOT** store items of interest to children over the unit. Children climbing to reach items could be seriously injured.

Child Safety (cont.)

- Children must be taught that the appliance and utensils in it can be hot. Let hot utensils cool in a safe place, out of reach of small children. Children should be taught that an appliance is not a toy. Children should not be allowed to play with controls or other parts of the appliance.

Cooking Safety

- **ALWAYS** place a pan on a surface element before turning it on. Be sure you know which knob controls which surface element. Make sure the correct element is turned on. When cooking is completed, turn element off before removing pan.
- **NEVER** leave a surface cooking operation unattended especially when using a high heat setting or when deep fat frying. Boilovers cause smoking and greasy spillovers may ignite. Clean up greasy spills as soon as possible. **DO NOT** use high heat for extended cooking operations.
- **NEVER** heat an unopened container on the surface element or in the oven. Pressure build-up may cause container to burst resulting in serious personal injury or damage to the appliance.
- Use dry, sturdy pot-holders. Damp pot-holders may cause burns from steam. Dishtowels or other substitutes should **NEVER** be used as potholders because they can trail across hot surface elements and ignite or get caught on appliance parts.
- **ALWAYS** let quantities of hot fat used for deep fat frying cool before attempting to move or handle.
- **DO NOT** let cooking grease or other flammable materials accumulate in or near the appliance, hood or vent fan. Clean hood frequently to prevent grease from accumulating on hood or filter. When flaming foods under the hood turn the fan off.
- **NEVER** wear garments made of flammable material or loose fitting or long-sleeved apparel while cooking. Clothing may ignite or catch utensil handles.
- **ALWAYS** place oven racks in the desired positions while oven is cool. Slide oven rack out to add or remove food, using dry, sturdy potholders. **ALWAYS** avoid reaching into the oven to add or remove food. If a rack must be moved while hot, use a dry potholder.
- **ALWAYS** turn the oven off at the end of cooking.
- Use care when opening the oven door. Let hot air or steam escape before moving or replacing food.
- **NEVER** use aluminum foil to cover oven racks or oven bottom. This could result in risk of electric shock, fire, or damage to the appliance. Use foil only as directed in this guide.
- **PREPARED FOOD WARNING:** Follow food manufacturer's instructions. If a plastic frozen food container and/or its cover distorts, warps, or is otherwise damaged during cooking, immediately discard the food and its container. The food could be contaminated.

Warnings

Cooking Safety (cont.)

- If you are “flaming” liquor or other spirits under an exhaust, **TURN THE FAN OFF**. The draft could cause the flames to spread out of control.

Utensil Safety

- Use pans with flat bottoms and handles that are easily grasped and stay cool. Avoid using unstable, warped, easily tipped or loose-handled pans. Also avoid using pans, especially small pans, with heavy handles as they could be unstable and easily tip. Pans that are heavy to move when filled with food may also be hazardous.
- Be sure utensil is large enough to properly contain food and avoid boilovers. Pan size is particularly important in deep fat frying. Be sure pan will accommodate the volume of food that is to be added as well as the bubble action of fat.
- To minimize burns, ignition of flammable materials and spillage due to unintentional contact with the utensil, **DO NOT** extend handles over adjacent burners. **ALWAYS** turn pan handles toward the side or back of the appliance, not out into the room where they are easily hit or reached by small children.
- **NEVER** let a pan boil dry as this could damage the utensil and the appliance.
- Follow the manufacturer's directions when using oven cooking bags.
- Only certain types of glass, glass/ceramic, ceramic or glazed utensils are suitable for rangetop surface or oven usage without breaking due to the sudden change in temperature. Follow manufacturer's instructions when using glass.
- This appliance has been tested for safe performance using conventional cookware. **DO NOT** use any devices or accessories that are not specifically recommended in this guide. **DO NOT** use eyelid covers for the surface units, stovetop grills, or add-on oven convection systems. The use of devices or accessories that are not expressly recommended in this manual can create serious safety hazards, result in performance problems, and reduce the life of the components of the appliance.

CAUTION

To avoid risk of property damage, **DO NOT** use cast iron cookware. Cast iron retains heat and may result in damaging the rangetop.

Heating Elements and Glass Ceramic Cooking Surfaces

- Surface areas on or adjacent to the unit may be hot enough to cause burns.
- **NEVER** touch oven heating elements, areas near elements, or interior surfaces of oven.
- Heating elements may be hot even though they are dark in color. Areas near elements and interior surfaces of an oven may become hot enough to cause burns.
- During and after use, **DO NOT** touch or let clothing or other flammable material contact surface of unit or areas near unit, heating elements, or interior surfaces of oven until they have had sufficient time to cool.
- **DO NOT COOK ON BROKEN COOKING SURFACE** – If cooking surface should break, cleaning solutions and spillovers may penetrate the broken cooking surface and create a risk of electric shock. Contact a qualified technician immediately.

Cleaning Safety

- Turn off all controls and wait for appliance parts to cool before touching or cleaning them. **DO NOT** touch the surface elements or surrounding areas until they have had sufficient time to cool.
- Clean appliance with caution. Use care to avoid steam burns if a wet sponge or cloth is used to wipe spills on a hot surface. Some cleaners can produce noxious fumes if applied to a hot surface.

Self-Clean Oven

- Clean only parts listed in this guide. **DO NOT** clean door gasket. The door gasket is essential for a good seal. Care should be taken not to rub, damage, or move the gasket. **DO NOT** use oven cleaners of any kind in or around any part of the self-clean oven.
- Before self-cleaning the oven, remove oven racks and other utensils and wipe up excessive spillovers to prevent excessive smoke, flare-ups or flaming.
- This range features a cooling fan which operates automatically during a clean cycle. If the fan does not turn on, cancel the clean operation and contact an authorized servicer.
- It is normal for the rangetop cooking surface of the range to become hot during a self-clean cycle. Therefore, touching the rangetop cooking surface during a clean cycle should be avoided.
- **NEVER** leave your residence when the self-clean function is operating.

Warnings

Important Safety Notice and Warning

The California Safe Drinking Water and Toxic Enforcement Act of 1986 (Proposition 65) requires the Governor of California to publish a list of substances known to the State of California to cause cancer or reproductive harm, and requires businesses to warn customers of potential exposures to such substances. Users of this appliance are hereby warned that when the oven is engaged in the self-clean cycle, there may be some low-level exposure to some of the listed substances, including carbon monoxide. Exposure to these substances can be minimized by properly venting the oven to the outdoors by opening the windows and/or door in the room where the appliance is located during the self-clean cycle.

Important notice regarding pet birds:

NEVER keep pet birds in the kitchen or in rooms where the fumes from the kitchen could reach. Birds have a very sensitive respiratory system. Fumes released during an oven self-cleaning cycle may be harmful or fatal to birds. Fumes released due to overheated cooking oil, fat, margarine and overheated non-stick cookware may be equally harmful.

⚠ WARNING

To avoid risk of injury or death, **NEVER** use appliance as a space heater to heat or warm a room to prevent potential hazard to the user and damage to the appliance. Also, **DO NOT** use the rangetop or oven as a storage area for food or cooking utensils.

About Your Appliance

- For proper oven performance and operation, **DO NOT** block or obstruct the oven vent duct located on the right side of the air grille.
- Avoid touching oven vent area while oven is on and for several minutes after oven is turned off. When the oven is in use, the vent and surrounding area become hot enough to cause burns. After oven is turned off, **DO NOT** touch the oven vent or surrounding areas until they have had sufficient time to cool.
- Other potentially hot surfaces include rangetop, areas facing the rangetop, oven vent, surfaces near the vent opening, oven door, areas around the oven door and oven window.
- The misuse of oven doors (e.g. stepping, sitting, or leaning on them) can result in potential hazards and/or injuries.

KEEP THESE INSTRUCTIONS FOR FUTURE REFERENCE.

⚠ WARNING



ELECTRICAL SHOCK HAZARD

To avoid risk of injury or death, **DO NOT** touch a hot oven light bulb with a damp cloth as the bulb could break. Should the bulb break, disconnect power to the appliance before removing bulb to avoid electrical shock.

⚠ WARNING



BURN OR ELECTRICAL SHOCK HAZARD

To avoid risk of injury or death, Make sure all controls are OFF and oven is COOL before cleaning. Failure to do so can result in burns or electrical shock.

⚠ CAUTION

To avoid sickness and food waste, **DO NOT** allow defrosted food to remain in the oven for more than two hours.

⚠ NOTICE

DO NOT turn the temperature control on during defrosting. Turning the convection fan on will accelerate the natural defrosting of the food without the heat.

⚠ CAUTION



BURN HAZARD

To avoid risk of injury, **DO NOT** touch the glass. The oven door, especially the glass, can get hot during usage.

Warnings

⚠ WARNING

This range features a self-cleaning cycle. During this cycle, the oven reaches elevated temperatures in order to burn off soil and deposits. A powder ash residue is left in the bottom of the oven after completion of the self-clean cycle.

NOTE: DO NOT use commercial oven cleaners inside the oven. Use of these cleaners can produce hazardous fumes or can damage the porcelain finishes. **DO NOT** line the oven with aluminum foil or other materials. These items can melt or burn during a self-clean cycle, causing permanent damage to the oven.

⚠ CAUTION



DO NOT touch the exterior portions of the oven after self-cleaning cycle has begun, since some parts become extremely hot to the touch!

During the first few times the self-cleaning feature is used, there may be some odor and smoking from the “curing” of the binder in the high-density insulation used in the oven. When the insulation is thoroughly cured, this odor will disappear. During subsequent self-cleaning cycles, you may sense an odor characteristic of high temperatures.

KEEP THE KITCHEN WELL-VENTED DURING THE SELF-CLEAN CYCLE.

⚠ CAUTION



FIRE HAZARD

You must carefully check the food during the dehydration process to ensure that it does not catch fire.

⚠ WARNING



BURN HAZARD

When self-cleaning, surfaces may get hotter than usual, therefore, children should be kept away.

⚠ CAUTION



FALLING HAZARD

DO NOT store items of interest to children over the unit. Children climbing to reach items could be seriously injured.

Before Using Range

All products are wiped clean with solvents at the factory to remove any visible signs of dirt, oil, and grease which may have remained from the manufacturing process. Before starting to cook, clean the range thoroughly with hot, soapy water. There may be some burn off and odors on first use of the appliance—this is normal.

Glass Rangetop

Clean your glass top before the first time you use it. A thorough cleaning with a glass top cleaner is recommended.

Oven

IMPORTANT! Before first use, wipe interior with soapy water and dry thoroughly. Then set the oven selector to bake, the thermostat to 450°F, and operate for an hour.

All models include:

- A broad range of baking and broiling modes—up to eight cooking modes in all—to make even your most challenging baking projects a success
- Strong, wear-resistant glass ceramic surface for excellent cleanability
- Split baking and broiling elements—which reduces preheating time and provides greater control and more even heating
- A reversing fan which is two times larger than most on the market—this allows you to cook foods more thoroughly and evenly—even when baking large quantities
- Four convection modes offering greater air circulation to shorten cooking times and cook foods more evenly
- Three broiling modes including a low-broil mode for delicate broiling and top-browning
- A profiled, concealed bake element for easier cleaning
- This appliance is certified by Star-K to meet strict regulations in conjunction with specific instructions found on www.star-k.org

Designer Range Features (RDSCE230-5B)

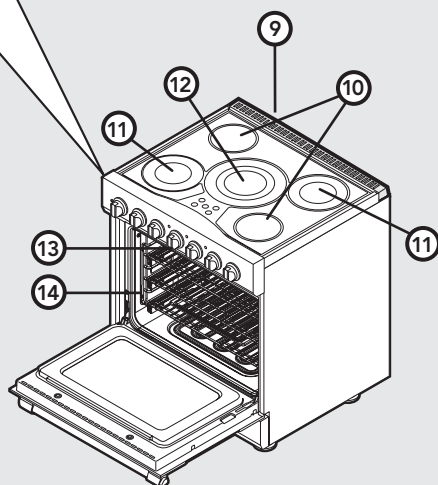
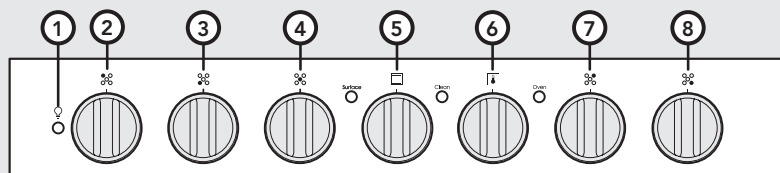

1. Interior oven light switch
2. Left rear element control knob
3. Left front element control knob
4. Center element control knob
5. Oven function selector knob
6. Oven temperature control knob
7. Right rear element control knob
8. Right front element control knob
9. Island trim
10. Two 6-1/2" 1,200 watt elements
11. Two 8-1/2" 2,000 watt dual elements
12. One 12" 3,200 watt triple element
13. Identification plate
14. Two TruGlide full extension racks/One standard rack/Six rack positions

Oven Functions and Settings

BAKE (Two-Element Bake)

Use this setting for baking, roasting, and casseroles.

CONV BAKE (Convection Bake)

Use this setting to bake and roast foods at the same time with minimal taste transfer.

TRU CONV (TruConvec™)

Use this bake setting for multi-rack baking of breads, cakes, and cookies. (up to six racks of cookies at once)

CONV ROAST (Convection Roast)

Use this setting for roasting whole turkeys, whole chickens, hams, etc.

CONV BROIL (Convection Broil)

Use this setting to broil thick cuts of meat.

HI BROIL

Use this setting for broiling dark meats at 1" thickness or less when rare or medium doneness is desired.

MED BROIL

Use this setting for broiling white meats such as chicken or meats greater than 1" thick that would be over-browned in high broil.

LOW BROIL

Use this setting for delicate broiling such as meringue.

SELF CLEAN

Use this function to clean oven.

Convection Dehydration (TRU CONV)

Use this function to dehydrate fruits and vegetables.

Convection Defrost (TRU CONV)

Use this function to defrost foods.

Note: For more information on oven functions see "Operation" section.

Surface Operation

About the Cooktop Surface Elements

Single radiant elements will have one round outline pattern shown on the cooktop and should be used when cooking with smaller cooking vessels. Dual radiant elements allows the user to set the smaller inner element alone or both the inner and outer elements may be used together when using medium to larger sized cookware. Triple element allows the use to set the smaller inner element, both inner and middle elements or all three elements if using larger sized cookware such as a stock pot.

Surface Burner Element

Push in and turn the control knob counterclockwise to the desired setting. The element will cycle on and off to maintain the desired heat setting. When finished, turn all controls to "OFF."

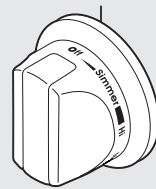

Hot Surface Indicator Lights

The range has four hot surface indicator lights. They are located in the center of the glass rangetop. The hot surface indicator light will glow red when the corresponding element is heated. The light will remain on after turning off the control knob until the corresponding element has cooled to a safe temperature.

Surface Operation

Surface Cooking Tips

- The minimum pot or pan (vessel) diameter recommended is 6" (15 cm). Use of pots or pans as small as 4" (10 cm) is possible but not recommended.

Surface Heat Settings

Heat Setting	Use
Simmer	Melting small quantities Steaming rice Simmering sauces
Low	Melting large quantities
Med Low	Low-temperature frying (eggs, etc.) Simmering large quantities Heating milk, cream sauces, gravies, and puddings
Med	Sauteing and browning, braising, and pan-frying Maintaining slow boil on large quantities
Med High	High-temperature frying Pan broiling Maintaining fast boil on large quantities
High	Boiling water quickly Deep-fat frying in large utensil

Note: The above information is given as a guide only. You may need to vary the heat settings to suit your personal requirements.

Cooking Vessels

Each cook has his or her own preference for the particular cooking vessels that are most appropriate for the type of cooking being done. Any and all cooking vessels are suitable for use in the range and it is not necessary to replace your present domestic vessels with commercial cookware. This a matter of personal choice. As with any cookware, yours should be in good condition and free from excessive dents on the bottom to provide maximum performance and convenience.

Note: When using big pots, it is recommended to use the center elements. There is more room in the center and potential cleanup of the appliance due to staining or discoloration will be minimized.

Oven Features

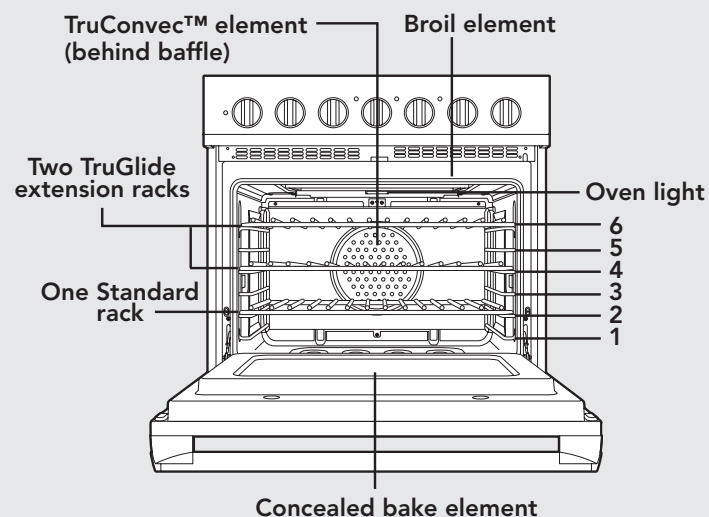

Rack Positions

Each oven is equipped with two full extension oven racks and one standard rack. All ovens have six rack positions. Position 6 is the farthest from the oven bottom. Position 1 is the closest to the oven bottom. The racks can be easily removed and arranged at various levels. For best results with conventional baking, **DO NOT** use more than one rack at a time. It is also recommended, when using two racks, to bake with the racks in positions 2 and 4 or positions 3 and 5.

Using the Oven

Preheat

For best results, it is extremely important that you preheat your oven to the desired cooking temperature before placing food items in the oven to begin cooking. In many cooking modes, partial power from the broiler is used to bring the oven to the preheat temperature. Therefore, placing food items in the oven during the preheat mode is not recommended. The Viking Rapid Ready™ Preheat System is engineered so that the oven is brought to the desired set temperature in a manner which will provide the optimum cooking environment based on the selected cooking mode in the shortest possible time.

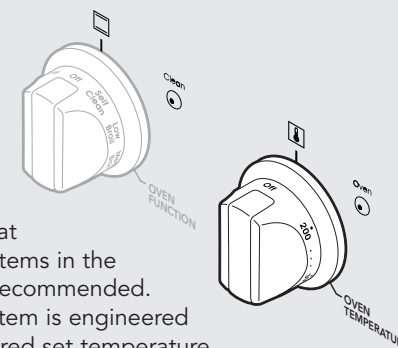

For instance, the preheat mode for TruConvec™ is designed to be brought up to the set point temperature in a different manner than the preheat mode for conventional bake. This is because TruConvec is designed for multi-rack baking. So it is extremely critical that all rack positions have reached the desired cooking temperature. As a result, it is normal for oven to take slightly longer for the oven to preheat to 350°F in TruConvec mode when compared to the amount of time it takes to preheat the oven cavity to 350°F in conventional bake mode.

Also, preheat time can vary based on some external factors such as room temperature and power supply. A significantly colder room temperature or a power supply less than 240 VAC can lengthen the time it takes for the oven to reach the desired set temperature.

Using the Oven

Conventional and Convection Cooking

Because of variations in food density, surface texture and consistency, some foods may be prepared more successfully using the conventional bake setting. For this reason, conventional baking is recommended when preparing baked goods such as custard. The user may find other foods that are also prepared more consistently in conventional bake. This is perfectly normal. Convection cooking is a cooking technique which utilizes fan forced air to circulate heat throughout the entire oven creating the optimum cooking environment. Cooking with convection is intended when performing multi-rack baking and for baking heavier foods.

Conventional and Convection Cooking Tips

- As a general rule, to convert conventional recipes to convection recipes, reduce the temperature by 25° F (-3.9°C) and the cooking time by approximately 10 to 15%.
- Cooking times for standard baking and convection baking will be the same. However, if using convection to cook a single item or smaller load, then it is possible to have 10-15% reduction in cooking time. (Remember convection cooking is designed for multi-rack baking or cooking large loads.)
- If cooking items which require longer than 45 minutes, then it is possible to see a 10-15% reduction in cooking time. This is especially true for large items cooked in the convection roast function.
- A major benefit of convection cooking is the ability to prepare foods in quantity. The uniform air circulation makes this possible. Foods that can be prepared on two of three racks at the same time include: pizza, cakes, cookies, biscuits, muffins, rolls, and frozen convenience foods.
- For three-rack baking, use any combination of rack positions 2, 3, 4, and 5. For two-rack baking, use rack positions 2 and 4 or positions 3 and 5. Remember that the racks are numbered from bottom to top. See "Oven Features" illustration.
- Items cooked in a convection function can be easily over baked. This being the case, it is usually a good idea to pull items out of the oven just before they seem to be done. Items will continue to cook right after they are set out of the oven.

Conventional and Convection Cooking Tips (cont.)

- Some recipes, especially those that are homemade, may require adjustment and testing when converting from standard to convection modes. If unsure how to convert a recipe, begin by preparing the recipe in conventional bake. After achieving acceptable results, follow the convection guidelines listed for the similar food type. If the food is not prepared to your satisfaction during this first convection trial, adjust only one recipe variable at a time (cooking time, rack position, or temperature) and repeat the convection test. Continue adjusting one recipe variable at a time until satisfactory results are achieved.

Pan Placement Tips

- When using large (15" x 13") flat pans or trays that cover most of the rack, rack positions 2 or 3 produce the best results.
- When baking on more than one rack, it is recommended to use one of the convection modes and the 2nd and 4th positions or the 3rd and 5th positions for more even baking. When baking on three racks, use any combination of positions 2, 3, 4, and 5 for more consistent results.
- Stagger pans in opposite directions when two racks and several pans are used in conventional bake. If possible, no pan should be directly above another.
- Allow 1 to 2 inches of air space around all sides of each pan for even air circulation.

Single Rack Pan Placement

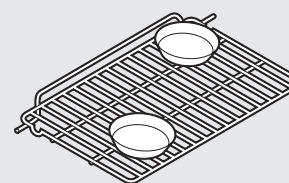

Multiple Rack Pan Placement

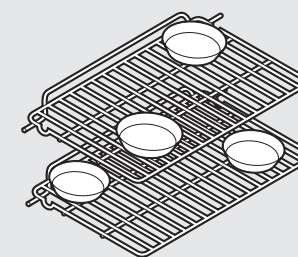

Baking

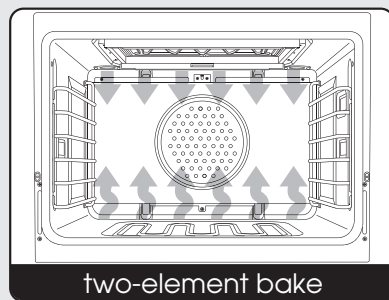

BAKE (Two-Element Bake)

Full power heat is radiated from the bake element in the bottom of the oven cavity and supplemental heat is radiated from the broil element. This function is recommended for single rack baking. Many cookbooks contain recipes to be cooked in the conventional manner. Conventional baking/

roasting is particularly suitable for dishes that require a high temperature. Use this setting for baking, roasting, and casseroles.

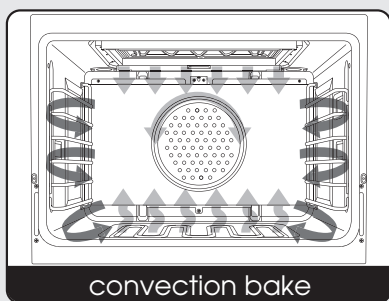

CONV BAKE (Convection Bake)

The bottom element operates at full power, and the top broil element operates at supplemental power. The heated air is circulated by the motorized fan in the rear of the oven providing a more even heat distribution. This even circulation of air equalizes the

temperature throughout the oven cavity and eliminates the hot and cold spots found in conventional ovens. A major benefit of convection baking is the ability to prepare food in quantity using multiple racks—a feature not possible in a standard oven.

When roasting using this setting, cool air is quickly replaced, searing meats on the outside and retaining more juices and natural flavor on the inside with less shrinkage. With this heating method, foods can be baked and roasted at the same time with minimal taste transfer, even when different dishes are involved, such as cakes, fish or meat. The hot air system is especially economical when thawing frozen food. Use this setting for baking and roasting.

TRU CONV (TruConvec™)

The rear element only operates at full power. There is no direct heat from the bottom or top elements. The motorized fan in the rear of the oven circulates air in the oven cavity for even heating. Use this setting for foods that require gentle cooking such as pastries, souffles, yeast breads, quick

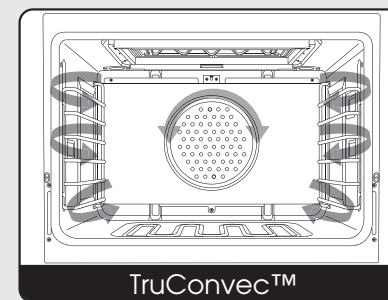

breads and cakes. Breads, cookies, and other baked goods come out evenly textured with golden crusts. No special bakeware is required. Use this function for single rack baking, multiple rack baking, roasting, and preparation of complete meals. This setting is also recommended when baking large quantities of baked goods at one time.

Baking Tips

- Make sure the oven racks are in the desired positions before turning the oven on.
- **DO NOT** open the oven door frequently during baking. If you must open the door, the best time is during the last quarter of the baking time.
- Bake to shortest time suggested and check for doneness before adding more time. For baked goods, a stainless steel knife placed in the center of the product should come clean when done.
- Use the pan size and type recommended by the recipe to ensure best results. Cakes, quick breads, muffins, and cookies should be baked in shiny, reflective pans for light, golden crusts. Avoid the use of old, darkened pans. Warped, dented, stainless steel and tin-coated pans heat unevenly and will not give uniform baking results.

Baking

Conventional Baking Chart

Food	Pan Size	Single Rack Position	Temp	Time (min)
BREADS				
Biscuits	Cookie sheet	3 or 4	400° F (204.4° C)	8 - 10
Yeast loaf	Loaf pan	3 or 4	375° F (190.6° C)	30 - 35
Yeast rolls	Cookie sheet	3 or 4	400° F (204.4° C)	12 - 15
Nut bread	Loaf pan	3 or 4	375° F (190.6° C)	30 - 35
Cornbread	8" x 8"	3 or 4	400° F (204.4° C)	20 - 25
Gingerbread	8" x 8"	3 or 4	350° F (176.7° C)	35 - 40
Muffins	Muffin tin	3 or 4	375° F (190.6° C)	15 - 20
Corn muffins	Muffin tin	3 or 4	375° F (190.6° C)	15 - 20
CAKES				
Angel food	Tube pan	3 or 4	375° F (190.6° C)	35 - 45
Bundt	Tube pan	3 or 4	350° F (176.7° C)	45 - 55
Cupcakes	Muffin pan	3 or 4	350° F (176.7° C)	16 - 20
Layer, sheet	13" x 9"	3 or 4	350° F (176.7° C)	40 - 50
Layer, two	9" round	3 or 4	350° F (176.7° C)	30 - 35
Pound	Loaf pan	3 or 4	350° F (176.7° C)	60 - 65
COOKIES				
Brownies	13" x 9"	3 or 4	350° F (176.7° C)	25 - 30
Choc. chip	Cookie sheet	3 or 4	375° F (190.6° C)	12 - 15
Sugar	Cookie sheet	3 or 4	350° F (176.7° C)	10 - 12
PASTRY				
Cream puffs	Cookie sheet	3 or 4	400° F (204.4° C)	30 - 35
PIES				
Crust, unfilled	9" round	3 or 4	425° F (218.3° C)	10 - 12
Crust, filled	9" round	3 or 4	375° F (190.6° C)	55 - 60
Lemon meringue	9" round	3 or 4	350° F (176.7° C)	12 - 15
Pumpkin	9" round	3 or 4	350° F (176.7° C)	40 - 45
Custard	6 - 4 oz cups	3 or 4	350° F (176.7° C)	35 - 40
ENTREES				
Egg rolls	Cookie sheet	3 or 4	400° F (204.4° C)	12 - 15
Fish sticks	Cookie sheet	3 or 4	425° F (218.3° C)	18 - 21
Lasagna, frz	Cookie sheet	3 or 4	375° F (190.6° C)	65 - 70
Pot pie	Cookie sheet	3 or 4	400° F (204.4° C)	35 - 40
Gr. peppers stuffed	13" x 9"	3 or 4	375° F (190.6° C)	65 - 70
Quiche	9" round	3 or 4	400° F (204.4° C)	25 - 30
Pizza, 12"	Cookie sheet	3 or 4	400° F (204.4° C)	15 - 20
Mac. & cheese, frz	Cookie sheet	3 or 4	375° F (190.6° C)	60 - 65
VEGETABLES				
Baked potatoes	On rack	3 or 4	375° F (190.6° C)	60 - 65
Spinach souffle	1 qt. casserole	3 or 4	350° F (176.7° C)	45 - 50
Squash	Cookie sheet	3 or 4	375° F (190.6° C)	50 - 55
French fries	Cookie sheet	3 or 4	425° F (218.3° C)	15 - 20

Note: The above information is given as a guide only.

Convection Baking Chart

Food	Pan Size	Single Rack Position	Temp	Time (min)
BREADS				
Biscuits	Cookie sheet	2 & 4	375° F (190.6° C)	7 - 9
Yeast loaf	Loaf pan	2 & 4	350° F (176.7° C)	20 - 25
Yeast rolls	Cookie sheet	2 & 4	375° F (190.6° C)	11 - 13
Nut bread	Loaf pan	2 & 4	350° F (176.7° C)	20 - 25
Cornbread	8" x 8"	2 & 4	375° F (190.6° C)	15 - 20
Gingerbread	8" x 8"	2 & 4	325° F (162.8° C)	30 - 35
Muffins	Muffin tin	2 & 4	350° F (176.7° C)	12 - 15
Corn muffins	Muffin tin	2 & 4	350° F (176.7° C)	0 - 12
CAKES				
Angel food	Tube pan	3 or 4	325° F (162.8° C)	30 - 35
Bundt	Tube pan	3 or 4	325° F (162.8° C)	35 - 40
Cupcakes	Muffin pan	2 & 4	325° F (162.8° C)	15 - 17
Layer, sheet	13" x 9"	2 & 4	325° F (162.8° C)	30 - 32
Layer, two	9" round	2 & 4	325° F (162.8° C)	25 - 30
Pound	Loaf pan	2 & 4	325° F (162.8° C)	5 - 50
COOKIES				
Brownies	13" x 9"	2 & 4	325° F (162.8° C)	20 - 25
Choc. chip	Cookie sheet	2,3,& 4	350° F (176.7° C)	7 - 10
Sugar	Cookie sheet	2,3,& 4	325° F (162.8° C)	9-10
PASTRY				
Cream puffs	Cookie sheet	2 & 4	375° F (190.6° C)	4 - 27
PIES				
Crust, unfilled	9" round	2 & 4	400° F (204.4° C)	7 - 9
Crust, filled	9" round	2 & 4	350° F (176.7° C)	50 - 55
Lemon meringue	9" round	2 & 4	325° F (162.8° C)	4 - 5
Pumpkin	9" round	2 & 4	325° F (162.8° C)	35 - 45
Custard	6 - 4 oz cups	2 & 4	325° F (162.8° C)	30 - 35
ENTREES				
Egg rolls	Cookie sheet	2 & 4	375° F (190.6° C)	8 - 10
Fish sticks	Cookie sheet	2 & 4	400° F (204.4° C)	13 - 16
Lasagna, frz	Cookie sheet	2 & 4	350° F (176.7° C)	60 - 65
Pot pie	Cookie sheet	2 & 4	375° F (190.6° C)	10 - 12
Gr. peppers stuffed	13" x 9"	2 & 4	350° F (176.7° C)	45 - 50
Quiche	9" round	2 & 4	375° F (190.6° C)	20 - 25
Pizza, 12"	Cookie sheet	2 & 4	375° F (190.6° C)	10 - 12
Mac. & cheese, frz	Cookie sheet	3 or 4	350° F (176.7° C)	45 - 50
VEGETABLES				
Baked potatoes	On rack	3 or 4	350° F (176.7° C)	45 - 50
Spinach souffle	1 qt. casserole	3 or 4	325° F (162.8° C)	35 - 40
Squash	Cookie sheet	3 or 4	350° F (176.7° C)	40 - 45
French fries	Cookie sheet	3 or 4	400° F (204.4° C)	10 - 15

Note: The above information is given as a guide only.

Solving Baking Problems

Baking problems can occur for many reasons. Check the chart below for the causes and remedies for the most common problems. It is important to remember that the temperature setting and cooking times you are accustomed to using with your previous oven may vary slightly from those required with this oven. If you find this to be true, it is necessary to adjust your recipes and cooking times accordingly.

Common Baking Problems/Remedies

Problems	Cause	Remedy
Cakes burned on the sides or not done in center	1. Oven was too hot 2. Wrong pan size 3. Too many pans	1. Reduce temperature 2. Use recom. pan size 3. Reduce no. of pans
Cakes crack on top	1. Batter too thick 2. Oven too hot 3. Wrong pan size	1. Follow recipe Add liquid 2. Reduce temperature 3. Use recom. pan size
Cakes are not level	1. Batter uneven 2. Oven or rack not level 3. Pan was warped	1. Distribute batter even 2. Level oven or rack 3. Use proper pan
Food too brown on bottom	1. Oven door opened too often 2. Dark pans being used 3. Incorrect rack position 4. Wrong bake setting 5. Pan too large	1. Use door window to check food 2. Use shiny pans 3. Use recom. rack position 4. Adjust to conventional or convection setting as needed 5. Use proper pan
Food too brown on top	1. Rack position too high 2. Oven not preheated 3. Sides of pan too high	1. Use recom. rack position 2. Allow oven to preheat 3. Use proper pans
Cookies too flat	1. Hot cookie sheet	1. Allow sheet to cool between batches
Pies burned around edges	1. Oven too hot 2. Too many pans used 3. Oven not preheated	1. Reduce temperature 2. Reduce no. of pans 3. Allow oven to preheat
Pies too light on top	1. Oven not hot enough 2. Too many pans used 3. Oven not preheated	1. Increase temperature 2. Reduce no. of pans 3. Allow oven to preheat

Roasting

CONV ROAST* (Convection Roast)

The convection element runs in conjunction with the inner and outer broil elements. The reversible convection fan runs at a higher speed in each direction. This transfer of heat (mainly from the convection element) seals moisture inside of large roasts. A time savings is gained over existing, single fan convection roast modes. Use this setting for whole turkeys, whole chickens, hams, etc.

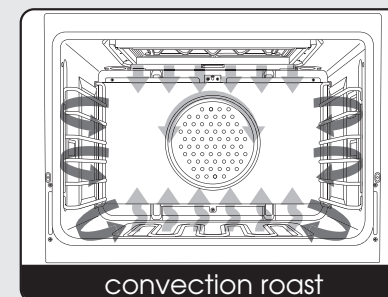

***Note:** This function uses a high-speed convection fan for optimum cooking performance. Some noise may be noticed from this high fan speed. This is normal.

Note: You can also roast foods using bake settings. See the "Baking" section for additional information.

Roasting Tips

ALWAYS use pans with low sides such as a broiler pan. The hot air must be allowed to circulate around the item being roasted. **DO NOT** cover what is being roasted. Convection roasting seals in juices quickly for a moist, tender product. Poultry will have a light, crispy skin and meats will be browned, not dry or burned. Cook meats and poultry directly from the refrigerator. There is no need for meat or poultry to stand at room temperature.

- As a general rule, to convert conventional recipes to convection recipes, reduce the temperature by 25° F (-3.9° C) and the cooking time by approximately 10 to 15%.
- **ALWAYS** roast meats fat side up in a shallow pan using a roasting rack. No basting is required when the fat side is up. **DO NOT** add water to the pan as this will cause a steamed effect. Roasting is a dry heat process.
- Poultry should be placed breast side up on a rack in a shallow pan. Brush poultry with melted butter, margarine, or oil before and during roasting.
- For convection roasting, **DO NOT** use pans with tall sides as this will interfere with the circulation of heated air over the food.
- If using a cooking bag, foil tent, or other cover, use the conventional bake setting rather than either convection setting.

Roasting

Roasting Tips (cont.)

- When using a meat thermometer, insert the probe halfway into the center of the thickest portion of the meat. (For poultry insert the thermometer probe between the body and leg into the thickest part of the inner thigh.) The tip of the probe should not touch bone, fat, or gristle to ensure an accurate reading. Check the meat temperature halfway through the recommended roasting time. After reading the thermometer once, insert it ½ inch (1.3 cm) further into the meat, then take a second reading. If the second temperature registers below the first, continue cooking the meat.
- Roasting times always vary according to the size, shape and quality of meats and poultry. Less tender cuts of meat are best prepared in the conventional bake setting and may require moist cooking techniques. Remove roasted meats from the oven when the thermometer registers 5° F (-15° C) to 10° F (-12° C) lower than the desired doneness. The meat will continue to cook after removal from the oven. Allow roasts to stand 15 to 20 minutes after roasting in order to make carving easier.

Conventional Roasting Chart
(when using the Bake or Convection Bake setting)

Food	Weight	Temp	Time (min/lb)	Internal Temp
BEEF				
Rib roast				
Rare	4 - 6 lbs	325° F (162.8° C)	25	140° F (60.0° C)
Medium	4 - 6 lbs	325° F (162.8° C)	30	155° F (68.3° C)
Well done	4 - 6 lbs	325° F (162.8° C)	40	170° F (76.7° C)
Rump roast				
Medium	4 - 6 lbs	325° F (162.8° C)	25	155° F (68.3° C)
Well done	4 - 6 lbs	325° F (162.8° C)	30	170° F (76.7° C)
Tip roast				
Medium	3 - 4 lbs	325° F (162.8° C)	35	155° F (68.3° C)
Well done	3 - 4 lbs	325° F (162.8° C)	40	170° F (76.7° C)
LAMB				
Lamb leg	3 - 5 lbs	325° F (162.8° C)	30	180° F (82.2° C)
PORK				
Pork loin	3 - 5 lbs	325° F (162.8° C)	35	180° F (82.2° C)
Pork chops 1" thick	1 - 1 1/4 lbs	350° F (176.7° C)	55 - 60 total time	N/A
Ham, fully cooked	5 lbs	325° F (162.8° C)	18	130° F (54.4° C)
POULTRY				
Chicken, whole	3 - 4 lbs	375° F (190.6° C)	30	180° F (82.2° C)
Turkey, unstuffed	12 - 16 lbs	325° F (162.8° C)	16 - 20	180° F (82.2° C)
Turkey	20 - 24 lbs	325° F (162.8° C)	16 - 20	180° F (82.2° C)
Turkey, stuffed	12 - 16 lbs	325° F (162.8° C)	17 - 21	180° F (82.2° C)
Turkey, stuffed	20 - 24 lbs	325° F (162.8° C)	17 - 21	180° F (82.2° C)
Turkey breast	4 - 6 lbs	325° F (162.8° C)	20	180° F (82.2° C)

Note: The above information is given as a guide only.

Roasting

Convection Roasting Chart

Food	Weight	Temp	Time (min/lb)	Internal Temp
BEEF				
Rib roast				
Rare	4 - 6 lbs	325° F (162.8° C)	25	140° F (60.0° C)
Medium	4 - 6 lbs	325° F (162.8° C)	24	155° F (68.3° C)
Well done	4 - 6 lbs	325° F (162.8° C)	30	170° F (76.7° C)
Rump roast				
Medium	4 - 6 lbs	325° F (162.8° C)	20	155° F (68.3° C)
Well done	4 - 6 lbs	325° F (162.8° C)	24	170° F (76.7° C)
Tip roast				
Medium	3 - 4 lbs	325° F (162.8° C)	30	155° F (68.3° C)
Well done	3 - 4 lbs	325° F (162.8° C)	35	170° F (76.7° C)
LAMB				
Lamb leg	3 - 5 lbs	325° F (162.8° C)	30	180° F (82.2° C)
PORK				
Pork loin	3 - 5 lbs	325° F (162.8° C)	30	180° F (82.2° C)
Pork chops 1" thick	1 - 1 1/4 lbs	325° F (162.8° C)	45 - 50 total time	N/A
Ham, fully cooked	5 lbs	325° F (162.8° C)	15	130° F (54.4° C)
POULTRY				
Chicken, whole	3-4 lbs	350 (176.7 C)	25	180° F (82.2° C)
Turkey, unstuffed	12 - 16 lbs	325° F (162.8° C)	11	180° F (82.2° C)
Turkey	20 - 24 lbs	325° F (162.8° C)	11	180° F (82.2° C)
Turkey, stuffed	12 - 16 lbs	325° F (162.8° C)	9 - 10	180° F (82.2° C)
Turkey, stuffed	20 - 24 lbs	325° F (162.8° C)	9 - 10	180° F (82.2° C)
Turkey breast	4 - 6 lbs	325° F (162.8° C)	20	180° F (82.2° C)

Note: The above information is given as a guide only.

Operation

Broiling

CONV BROIL* (Convection Broil)

The top element operates at full power. This function is exactly the same as regular broiling with the additional benefit of air circulation by the motorized fan in the rear of the oven. Smoke is reduced since the airflow also reduces peak temperatures on the food. Use this setting for broiling thick cuts of meats.

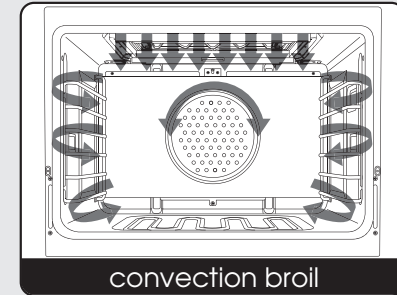

convection broil

***Note:** This function uses a high-speed convection fan for optimum cooking performance. Some noise may be noticed from this high fan speed. This is normal.

HI BROIL

Heat radiates from both broil elements, located in the top of the oven cavity, at full power. The distance between the foods and the broil elements determines broiling speed. For fast broiling, food may be as close as 2 inches (5 cm) to the broil element or on the top rack. Fast broiling is best for meats where rare to medium doneness is desired. Use this setting for broiling small and average cuts of meat.

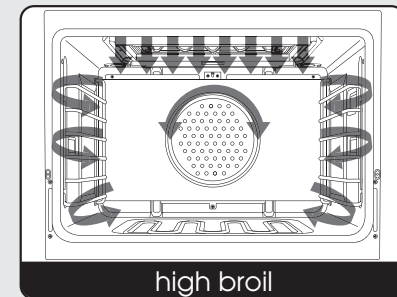

high broil

MED BROIL

Inner and outer broil elements pulse on and off to produce less heat for slow broiling. Allow about 4 inches (10 cm) between the top surface of the food and the broil element. Slow broiling is best for chicken and ham in order to broil food without over-browning it. Use this setting for broiling small and average cuts of meat.

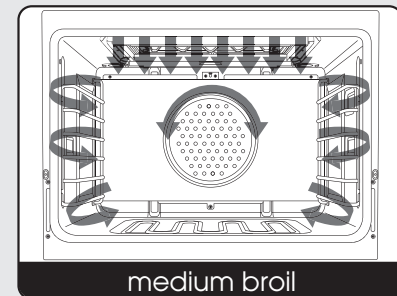

medium broil

Operation

Broiling

LOW BROIL

This mode uses only a fraction of the available power to the inner broil element for delicate top-browning. The inner broil element is on for only part of the time. Use this setting to gently brown meringue on racks 3 or 4 in 3-4 minutes.

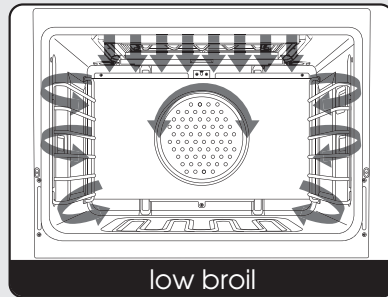

Broiling Instructions

Broiling is a dry-heat cooking method using direct or radiant heat. It is used for small, individualized cuts such as steaks, chops, and patties. Broiling speed is determined by the distance between the food and the broil element. Choose the rack position based on desired results.

Conventional broiling (LOW, MED or HI BROIL) is most successful for cuts of meat 1-2 inches thick and is also more suitable for flat pieces of meat. Convection broiling has the advantage of broiling food slightly quicker than conventional. Convection broiling of meats produces better results, especially for thick cuts. The meat sears on the outside and retains more juices and natural flavor inside with less shrinkage.

1. Arrange the oven rack in the desired position before turning broiler on.
2. Center the food on cold broiler pan. Place broiler pan in oven.
3. Set the oven function selector to desired broiling function and the temperature control knob to "Broil".
4. Close the door. There is not a detent to hold the door in the open broil stop position. With open door broiling the broil element does not cycle on and off. With closed door broiling the broil element might cycle on and off if an extended broiling time is required. A built-in smoke "eliminator" in the top of the oven helps reduce smoke and odors.

Broiling Tips

- **ALWAYS** use a broiler pan and grid for broiling. They are designed to provide drainage of excess liquid and fat away from the cooking surface to help prevent splatter, smoke, and fire.
- To keep meat from curling, slit fatty edge.
- Brush chicken and fish with butter several times as they broil to prevent drying out. To prevent sticking, lightly grease broiler tray.
- Broil on first side for slightly more than half the recommended time, season, and turn. Season second side just before removing.
- **ALWAYS** pull rack out to stop position before turning or removing food.
- Use tongs or a spatula to turn meats. **NEVER** pierce meat with a fork, as this allows the juices to escape.
- Remove the broiler pan from the oven when you remove the food. Drippings will bake onto the pan if it is left in the heated oven after broiling. While pan is hot, place damp paper towel over grid. Drizzle with liquid dishwashing detergent and pour water over grid. This will make cleaning of the pan easier, or the broiler pan can be lined with aluminum foil to make cleaning easier. Be sure the foil extends up the side of the pan. Although it is not recommended, the grid can also be covered with foil. Be sure to slit openings to conform with the openings in the grid so melted fat can drain through to prevent splattering, smoking, or the possibility of grease fire.

Broiling

Broiling Chart

Type and Cut of Meat	Weight	Setting	Rack	Time (min)
BEEF				
Sirloin, 1"				
Rare	12 oz	Conventional Broil	5	7
Medium	12 oz	Conventional Broil	5	9
Well done	12 oz	Conventional Broil	5	11
T-Bone, 3/4"				
Rare	10 oz	Conventional Broil	5	5
Medium	10 oz	Conventional Broil	5	7
Well done	10 oz	Conventional Broil	5	9
Hamburger, 1/2"				
Rare	1/4 lb.	Convection Broil	5	4
Medium	1/4 lb.	Convection Broil	5	7
Well done	1/4 lb.	Convection Broil	5	9
CHICKEN				
Bnls breast	1 lb.	Convection Broil	4	18
Bone-in breast	2 - 2 1/2 lb.	Conventional Broil	4	20
Chicken pieces	2 - 2 1/2 lb.	Convection Broil	4	18 (min/lb)
HAM				
Ham slice, 1"	1 lb.	Conventional Broil	4	22
LAMB				
Rib chops, 1"	12 oz.	Convection Broil	5	7
Shoulder	1 lb.	Convection Broil	5	6
PORK				
Loin chops, 3/4"	1 lb.	Convection Broil	4	14
Bacon		Conventional Broil	4	6
FISH				
Salmon steak	1 lb.	Convection Broil	5	7
Filletts	1 lb.	Convection Broil	5	6

Note: The above information is given as a guide only.

Convection Dehydrate/Defrost

Convection Dehydrate

This oven is designed not only to cook, but also to dehydrate fruits and vegetables.

1. Prepare the food as recommended.
2. Arrange the food on drying racks (not included with the oven; contact a local store handling speciality cooking utensils).
3. Set the appropriate low temperature and turn the selector to "TRU CONV".

⚠ CAUTION

 **FIRE HAZARD**
 You must carefully check the food during the dehydration process to ensure that it does not catch fire.

Convection Defrost

1. Place the frozen food on a baking sheet.
2. Set the temperature control to "OFF".
3. Turn the selector to "TRU CONV".

⚠ WARNING

To avoid sickness and food waste, **DO NOT** allow defrosted food to remain in the oven for more than two hours.

⚠ NOTICE

DO NOT turn the temperature control on during defrosting. Turning the convection fan on will accelerate the natural defrosting of the food without the heat.

Cleaning and Maintenance

Any piece of equipment works better and lasts longer when maintained properly and kept clean. Cooking equipment is no exception. Your range must be kept clean and maintained properly. Make sure all controls are in the "OFF" position. Disconnect power if you are going to clean thoroughly with water.

Glass Ceramic Top

Cleaning of glass ceramic tops is different from cleaning a standard porcelain finish. To maintain and protect the surface of your new glass ceramic top, follow these basic steps:

For normal light soil:

Rub a few drops of a glass ceramic cream to the cool soiled area using a damp paper towel. Wipe until all soil and cream are removed. Frequent cleaning leaves a protective coating which is essential in preventing scratches and abrasions.

For heavy, burned soil:

1. Apply a few drops of glass ceramic cleaning cream to the cool soiled area.
2. Using a damp paper towel, rub cream into burned on area.
3. Carefully scrape remaining soil with a razor scraper. Hold the scraper at a 30° angle against the ceramic surface.
4. If any soil remains, repeat the steps listed above. For additional protection, after all soil has been removed, polish the entire surface with the cleaning cream.
5. Buff with a dry paper towel. As the cleaning cream cleans, it leaves a protective coating on the glass surface. This coating helps to prevent build-up of mineral deposits (water spots) and will make future cleaning easier. Dishwashing detergents remove this protective coating and therefore make the glass ceramic top more susceptible to staining.

Cleaning and Maintenance

Cleaning Problems on Glass Ceramic Top

Problem	Cause	To Prevent	To Remove
Brown streaks and specks	Cleaning with sponge or cloth containing soil-laden detergent water.	Use cleaning cream with clean damp paper towel.	Use a light application of cleaning cream with a clean damp paper towel.
Blackened burned on spots	Spatters or spillovers onto a hot cooking area or accidental melting of a plastic film, such as a bread.	Wipe all spillovers as soon as it is safe and to not put plastic items on a warm cooking area.	Clean area with cleaning cream and a damp paper towel, non-abrasive nylon pad or scouring brush. If burn-on is not removed, cool cooktop, and carefully scrape area with a single edged razor blade held at a 30° angle.
Fine brown/gray lines or fine scratches or abrasions which have collected soil	Coarse particles (salt, sugar) can get caught on the bottom of cookware and become embedded into top. Using abrasive cleaning materials. Scratches from rough ceramic glass, or ceramic coated cookware.	Wipe the bottom of cookware before cooking. Clean top daily with cleaning cream. DO NOT use ceramic or ceramic coated cookware.	Fine scratches are not removable but can be minimized by daily use of cleaning cream.
Smearing or streaking	Use of too much cleaning cream or use of a soiled dishcloth.	Use a small amount of cream. Rinse thoroughly before drying. Use only paper towels or nylon scrub pad or brush.	Dampen paper towel with a mixture of vinegar and water and wipe surface. Wipe area with damp paper towel or lint free cloth.

Cleaning and Maintenance

Cleaning Problems on Glass Ceramic Top (cont.)

Problem	Cause	To Prevent	To Remove
Metal markings silver/gray marks	Sliding or scraping metal utensils on glasstop.	DO NOT slide metal objects across top.	Remove metal marks before the glasstop is used again. Apply cleaning cream with a damp paper towel and scrub with a nylon scrub pad or brush. Rinse thoroughly and dry.
Hard water spots	Condensation from cooking may cause minerals found in water and acids to drip on glasstop and cause gray deposits. The spots are often so thin they appear to be in or the glasstop.	Make sure the bottom of utensils are dry before cooking. Daily use of cleaning cream will help keep top free from hard water mineral deposits and food discoloration.	Mix cleaning cream with water and apply a thick paste to stained area. Scrub vigorously. If stain is not removed, reapply cleaner and repeat process. Also try cleaning procedure for smearing and streaking.
Pitting or flaking	Boil over of sugar syrup on glasstop. This can cause pitting if not removed immediately.	Watch sugar and syrups carefully to avoid boilovers.	Turn element to LO; using several paper towels to wipe the spill immediately. Let glasstop cool and carefully scrape off remainder of burn-off with a single edged razor held at a 30° angle.

Control Panel

DO NOT use any cleaners containing ammonia or abrasives. They could remove the graphics from the control panel. Use hot, soapy water and a soft clean cloth.

Oven Surfaces

Several different finishes have been used in your electric oven. Cleaning instructions for each surface are given below. The oven features a self-clean cycle for the oven interior. See the "Self-Clean Cycle" section for complete instructions. **NEVER USE AMMONIA, STEEL WOOL PADS OR ABRASIVE CLOTHS, CLEANSERS, OVEN CLEANERS, OR ABRASIVE POWDERS. THEY CAN PERMANENTLY DAMAGE YOUR OVEN.**

Control Knobs

MAKE SURE ALL CONTROL KNOBS POINT TO THE "OFF" POSITION BEFORE REMOVING. Pull the knobs straight off. Wash in detergent and warm water. Dry completely and replace by pushing firmly onto stem.

Stainless Steel Parts

All stainless steel body parts should be wiped regularly with hot soapy water at the end of each cooling period and with a liquid cleaner designed for that material when soapy water will not do the job. **DO NOT** use steel wool, abrasive cloths, cleansers, or powders. If necessary, scrape stainless steel to remove encrusted materials, soak the area with hot towels to loosen the material, then use a wooden or nylon spatula or scraper. **DO NOT** use a metal knife, spatula, or any other metal tool to scrape stainless steel. **DO NOT** permit citrus or tomato juice to remain on stainless steel surface, as citric acid will permanently discolor stainless steel. Wipe up any spills immediately.

Self-Clean Cycle

Oven Racks

Clean with detergent and hot water. Stubborn spots can be scoured with a soap-filled steel wool pad. **DO NOT CLEAN THE OVEN RACKS OR RACK SUPPORT USING THE SELF-CLEAN CYCLE.** They could sustain damage due to the extreme heat of the self-clean cycle.

Power Failure

No attempt should be made to operate the appliance during a power failure. Make sure the oven control is in the "OFF" position.

Momentary power failure can occur unnoticed. The range is affected only when the power is interrupted. When it comes back on, the range will function properly without any adjustments. A "brown-out" may or may not affect range operation, depending on how severe the power loss is. If the range is in the self-clean cycle when the power failure occurs, wait until power is restored and allow door to unlock automatically. Turn all controls off and restart self-clean cycle again, according to instructions.

This oven features an automatic pyrolytic self-cleaning cycle. During this cycle, the oven reaches elevated temperatures in order to burn off soil and deposits. An integral smoke eliminator helps reduce odors associated with the soil burn-off. A powder ash residue is left in the bottom of the oven after completion of the self-clean cycle. The door latch is automatically activated after selecting the self-clean setting. The latch ensures that the door cannot be opened while the oven interior is at clean temperatures.

Before starting the Self-Clean cycle:

1. Remove the oven racks, and any other items/utensils from the oven. The high heat generated during the cleaning cycle can discolor, warp, and damage these items. **DO NOT** use foil or liners in the oven. During the self-clean cycle foil can burn or melt and damage the oven surface.
2. Wipe off any large spills from the oven bottom and sides. **NEVER** use oven cleaners inside a self-cleaning oven or on raised portions of the door.
3. Some areas of the oven must be cleaned by hand before the cycle begins. Soils in these areas will be baked on and very difficult to clean if not removed first. Clean the door up to the gasket, the door frame, and up to 2 inches inside the frame with detergent and hot water. Rinse thoroughly and dry.

⚠ WARNING



BURN OR ELECTRICAL SHOCK HAZARD

Make sure all controls are OFF and oven is COOL before cleaning. Failure to do so can result in burns or electrical shock.

⚠ CAUTION

DO NOT touch the exterior portions of the oven after self-cleaning cycle has begun, since some parts become extremely hot to the touch! During the first few times the self-cleaning feature is used, there may be some odor and smoking from the curing of the binder in the high-density insulation used in the oven. When the insulation is thoroughly cured, this odor will disappear. During subsequent self-cleaning cycles, you may sense an odor characteristic of high temperatures. Keep the kitchen well-vented during the self-cleaning cycle.

Replacing Oven Lights

To start the Self-Clean cycle:

1. Close the door completely.
2. Turn the oven selector knob clockwise to the "SELF CLEAN" mode.
3. Turn the temperature control knob past the clean setting until the knob stops. At this time, the clean indicator light will come on. Within 30 seconds the automatic door latch engages and the oven indicator light comes on. The oven indicator light will remain on until the oven reaches the self-clean temperature and will then cycle on and off during the self-clean cycle. When the oven reaches the elevated temperature needed for self-clean, the door lock indicator light comes on.
4. The door lock indicator light will remain on until the self-clean is completed or interrupted and the oven temperature drops to a safe temperature. A complete cycle is approximately 3-1/2 hours with an additional 30 minutes needed for the oven to cool down enough for the door latch to disengage.

Note: A fan noise will be heard during the self-clean cycle and will continue to run for the 3-1/2 hour duration of the self-clean cycle.

5. When the cycle is completed, turn both the oven selector and temperature control knob to the "OFF" position. When the oven has completely cooled, open door and remove any ash from the oven surfaces with a damp cloth.

To stop the Self-Clean cycle:

To cancel or interrupt the self-cleaning cycle, turn both the temperature control knob and the oven function selector knob to "OFF". When the oven temperature drops to a safe temperature, the automatic door latch will release and the oven door can be opened. When the oven has completely cooled, remove any ash from the oven surfaces with a damp sponge or cloth.

⚠ WARNING



ELECTRICAL SHOCK HAZARD

Disconnect the electric power at the main fuse or circuit breaker before replacing bulb.

⚠ CAUTION

To avoid risk of personal injury, **DO NOT** touch bulb with bare hands. Clean off any signs of oil from the bulb and handle with a soft cloth.

1. Unsnap glass light cover using a screwdriver in the access groove.
2. Firmly grasp light bulb and pull out.
3. Replace with halogen bulb using volt and wattage requirements listed on glass cover.
4. Replace the light cover by snapping glass cover onto metal box.
5. Reconnect power at the main fuse or circuit breaker.

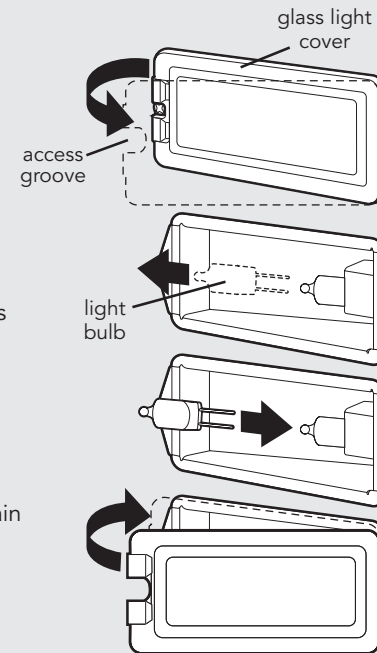

Door Removal

⚠ WARNING

TO PREVENT PERSONAL INJURY

Before removing the doors, make sure the pins are properly installed in the hinges. Failure to do so can result in personal injury to hands and/or fingers.

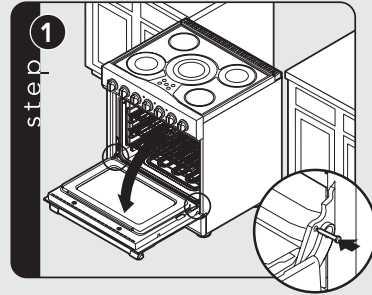

Open door completely.
Place pin in pin hole.

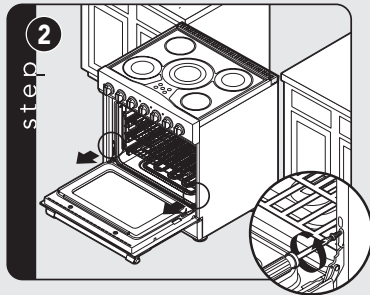

Remove hinge trim screws
and hinge trim.

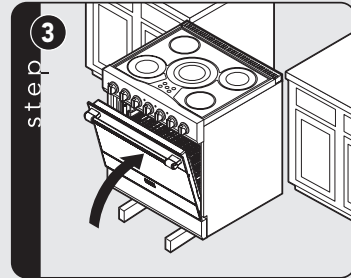

Close until pins stop door.

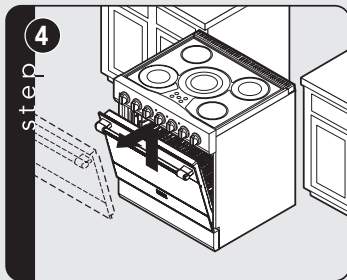

Lift door up and out.

Note: Professional oven shown.

Door Replacement and Adjustment

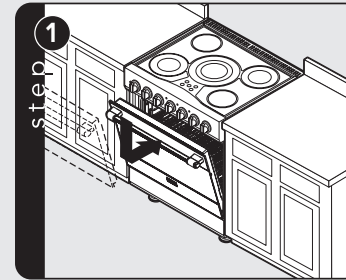

Reinstall door to range.

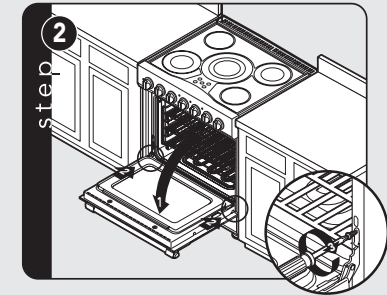

Open door completely.
Reinstall hinge trim.

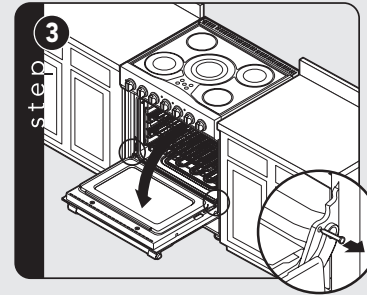

Remove pins from hole in hinges.

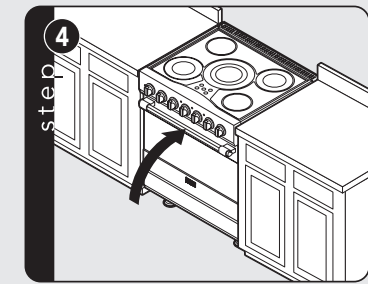

Close door.

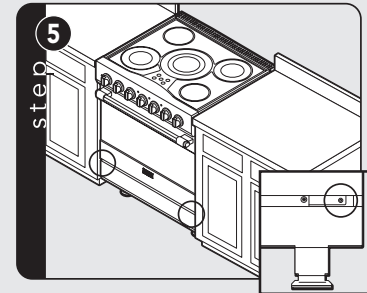

If the door needs to be adjusted, loosen hinge trim screws (see step 2). Adjust the screws located between the door and kickplate using a 5/32" hex head allen wrench. After adjustment, tighten hinge trim screws.

Troubleshooting

Problem	Possible Cause and/or Remedy
Range will not function.	Range is not connected to electrical power: Have electrician check power circuit breaker, wiring, and fuses.
Oven does not operate in self-clean.	Door is not shut tight enough for automatic door latch to lock.
Oven is not clean after self-clean cycle.	Temperature control knob not rotated all the way past clean until it stops.
Broil does not work.	Temperature control knob is rotated too far past broil position.
Door will not open.	Oven is still in self-clean mode. If oven is hot, door latch will release when safe temperature is reached.
Oven light will not work.	Light bulb is burned out. Range is not connected to power.

Service Information

If service is required, call your dealer or authorized service agency. The name of the authorized service agency can be obtained from the dealer or distributor in your area.

Have the following information readily available.

- Model number
- Serial number
- Date purchased
- Name of dealer from whom purchased

Clearly describe the problem that you are having. If you are unable to obtain the name of an authorized service agency, or if you continue to have service problems, contact Viking Range Corporation at 1-888-845-4641, or write to:

**VIKING RANGE CORPORATION
PREFERRED SERVICE
1803 Hwy 82W
Greenwood, Mississippi 38930 USA**

The serial number and model number for your range can be found by opening the door and looking under the control panel.

Record the information indicated below. You will need it if service is ever required.

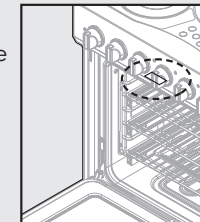

Model no. _____ Serial no. _____

Date of purchase _____ Date installed _____

Dealer's name _____

Address _____

If service requires installation of parts, use only authorized parts to insure protection under the warranty.

Keep this manual for future reference.

Warranty

ELECTRIC RANGE WARRANTY

THREE YEAR FULL WARRANTY

Freestanding electric ranges and all of their component parts, **except as detailed below*†**, are warranted to be free from defective materials or workmanship in normal residential use for a period of three (3) years from the date of original retail purchase or closing date for new construction, whichever period is longer. Viking Range Corporation, warrantor, agrees to repair or replace, at its option, any part which fails or is found to be defective during the warranty period.

***FULL NINETY (90) DAY COSMETIC WARRANTY:** Product is warranted to be free from cosmetic defects in materials or workmanship (such as scratches on stainless steel, paint/porcelain blemishes, etc.) for a period of ninety (90) days from the date of original retail purchase or closing date for new construction, whichever period is longer. Any defects must be reported to the selling dealer within ninety (90) days from date of original retail purchase. Viking Range Corporation uses high quality processes and materials available to produce all color finishes. However, slight color variation may be noticed because of the inherent differences in painted parts and porcelain parts as well as differences in kitchen lighting, product locations, and other factors. Therefore, this warranty does not apply to color variation attributable to such factors.

†FULL NINETY (90) DAY WARRANTY IN "RESIDENTIAL PLUS" APPLICATIONS: This full warranty applies to applications where use of the product extends beyond normal residential use, but the warranty period for products used in such applications is ninety (90) days. Examples of applications covered by this warranty are bed and breakfasts, fire stations, private clubs, churches, yachts, etc. Under this "Residential Plus" warranty, the product, its components and accessories are warranted to be free from defective material or workmanship for a period of ninety (90) days from the date of original retail purchase. This warranty excludes use of the product in all commercial locations such as restaurants, food service locations and institutional food service locations.

FIVE YEAR LIMITED WARRANTY ON BURNERS

Any surface burner, griddle burner, grill burner, or oven burner which fails due to defective materials or workmanship (excluding cosmetic failures) in normal household use during the fourth through fifth year from the date of original retail purchase will be repaired or replaced, free of charge for the part itself, with the owner paying all other costs, including labor. This does not include ignition systems, burner bases, etc.

TEN YEAR LIMITED WARRANTY ON PORCELAIN

Any porcelain oven or porcelain inner door panel which rusts through due to defective materials or workmanship in normal household use during the fourth through the tenth year from the date of original retail purchase will be repaired or replaced, free of charge for the part itself, with the owner paying all other costs, including labor.

TERMS AND CONDITIONS

This warranty extends to the original purchaser of the product warranted hereunder and to each transferee owner of the product during the term of the warranty and applies to products purchased and located in the United States and Canada. Products must be purchased in the country where service is requested. If the product or one of its component parts contains a defect or malfunction during the full warranty period after a reasonable number of attempts by the warrantor to remedy the defect or malfunction, the owner is entitled to either a refund or replacement of the product or its component part or parts. Replacement of a component part includes its free installation, except as specified under the limited warranty. Under the terms of this warranty, service must be performed by a factory authorized Viking Range Corporation service agent or representative. Service will be provided during normal business hours, and labor performed at overtime or premium rates shall not be covered by this warranty. Owner shall be responsible for proper installation, providing reasonable and necessary maintenance, providing proof of purchase upon request, and making the appliance reasonably accessible for service. The return of the Owner Registration Card is not a condition of warranty coverage. You should, however, return the Owner Registration Card so that Viking Range Corporation can contact you should any question of safety arise which could affect you.

This warranty gives you specific legal rights, and you may also have other rights which may vary from jurisdiction to jurisdiction.

WHAT IS NOT COVERED BY THIS WARRANTY: This warranty shall not apply to damage resulting from abuse, failure to provide reasonable and necessary maintenance, accident, delivery, negligence, natural disaster, loss of electrical power to the product for any reason, alteration, outdoor use, improper installation, improper operation, or repair or service of the product by anyone other than an authorized Viking Range Corporation service agency or representative. This warranty does not apply to commercial usage.

Warranty (cont.)

LIMITATION OF REMEDIES AND DURATION OF IMPLIED WARRANTY
OWNER'S SOLE AND EXCLUSIVE REMEDY FOR A CLAIM OF ANY KIND WITH RESPECT TO THIS PRODUCT SHALL BE THE REMEDIES SET FORTH ABOVE. VIKING IS NOT RESPONSIBLE FOR CONSEQUENTIAL OR INCIDENTAL DAMAGE, INCLUDING BUT NOT LIMITED TO FOOD OR MEDICINE LOSS, DUE TO PRODUCT FAILURE, WHETHER ARISING OUT OF BREACH OF WARRANTY, BREACH OF CONTRACT OR OTHERWISE. Some jurisdictions do not allow the exclusion or limitation of incidental or consequential damages, so the above limitation or exclusions may not apply to you. **ANY IMPLIED WARRANTIES OF MERCHANTABILITY OR FITNESS FOR A PARTICULAR PURPOSE APPLICABLE TO THIS PRODUCT ARE LIMITED IN DURATION TO THE PERIOD OF COVERAGE OF THE APPLICABLE EXPRESS WRITTEN LIMITED WARRANTIES SET FORTH ABOVE.** Some states do not allow limitations on how long an implied warranty lasts, so the above limitation may not apply to you.

WARRANTY SERVICE

To obtain warranty service, contact an authorized Viking Range Corporation service agent, or Viking Range Corporation, 111 Front Street, Greenwood, Mississippi 38930, (888) 845-4641. Provide model and serial number and date of original purchase or closing date for a new construction. For the name of your nearest authorized Viking Range Corporation service agency, call Viking Range Corporation. **IMPORTANT:** Retain proof of original purchase to establish warranty period.

Specifications subject to change without notice.

